

# User Manual

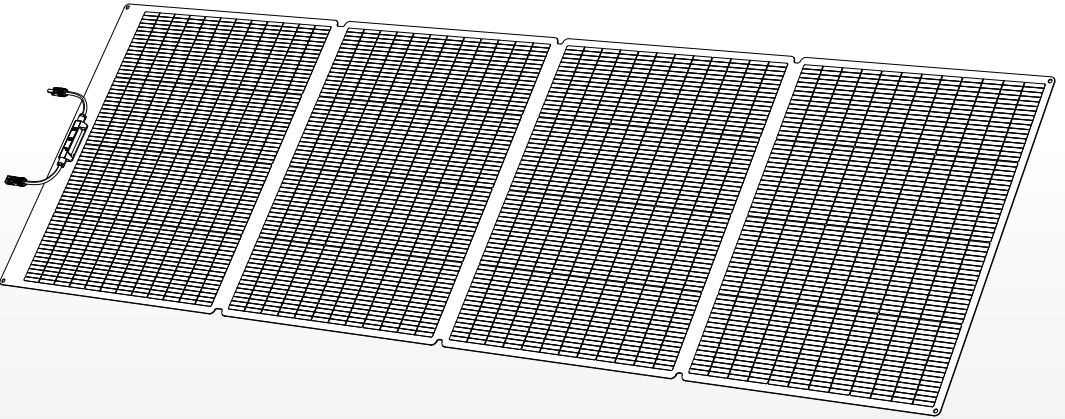

# PV 360W

**360W** Solar Panel

# Contents

<b>Disclaimer</b>	01
<b>Product List</b>	02
<b>Product Description</b>	03–04
Specifications	03
Product Description	04
<b>Instructions for Use</b>	05
<b>Connection and Calculation Method</b>	06–07
In Series	08–09
In Parallel	08
<b>FAQ</b>	09
<b>Compliance and Certification</b>	10

# Disclaimer

Before using this product, please read this user manual carefully to ensure that you fully understand the product and can use it correctly. After reading this user manual, please keep it in a safe place for future reference. Improper use of this product may cause serious injury to yourself or others, or result in product damage and property loss. By using this product, you are deemed to have understood, recognized and accepted all the terms and contents of this document. The Company shall not be responsible for any damages caused by the user's failure to use this product in accordance with this user manual.

In accordance with laws and regulations, the company reserves the right of final interpretation of this document and all documents related to this product. This document is subject to change, update, revision or termination without notice.

Please visit our website for the latest product information.

- The company shall not be held responsible for any damage caused by force majeure (e.g. fire, typhoon, flood, earthquake) or use under other abnormal circumstances by the customer.
- The company bears no responsibility for loss caused by the use of non-standard connectors.
- The company shall not be liable for any damage caused by non-compliance with the standard operation.
- Please do not disassemble the product. Otherwise, the warranty will be voided.

# Product List

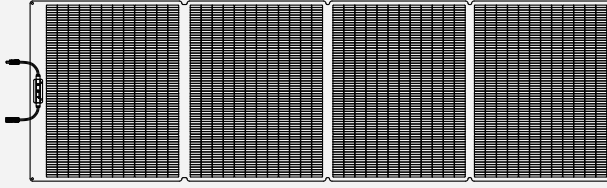

Solar Panel

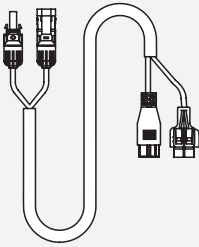

MC4 to XT60 and  
Anderson Extension Cable

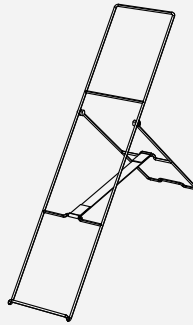

Detachable Kickstand\*3

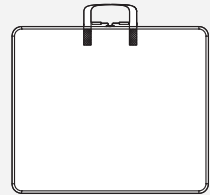

Carry Bag

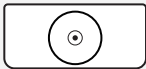

Sundial Indicator

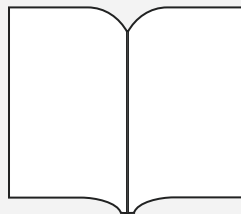

User Manual



Warranty Card

# Product Description

## ⚡ Specifications

Rated Power	360W
Cell Efficiency	25%
Open Circuit Voltage	36.0V
Short Circuit Current	12.72A
Maximum Operating Voltage	30.0V
Maximum Operating Current	12.00A
IP Grade	IP68
Working Temperature	-4°F~140°F (-20°C~60°C)
Dimension	Folded: 5.83*30.31*1.18in (656*770*30mm)
	Unfolded: 97.76*30.31*0.98in (2483*770*25mm)
Net Weight	24.03lb (10.9kg)

# Product Description

## ⚡ Overview

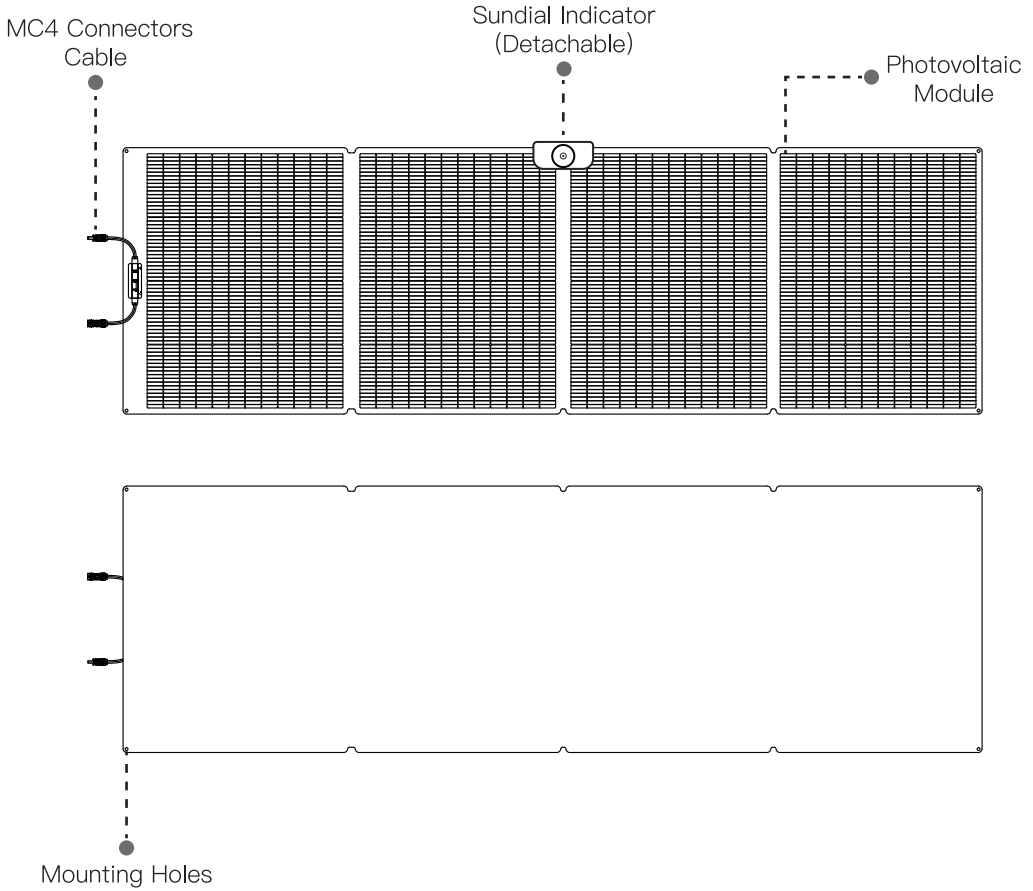

# Instructions for Use

- 1 Space the kickstands evenly according to the solar panel, adjusting the strap length to achieve the desired sunlight angle.
- 2 Adjust the orientation of the kickstands, unfold the solar panel, and secure it onto the kickstands.
- 3 Attach sundial indicator on the top of photovoltaic module to focus sunlight within the sundial indicator's circle for optimal illumination at its center.
- 4 Connect the solar panel to the solar input port of the portable power station and start charging.

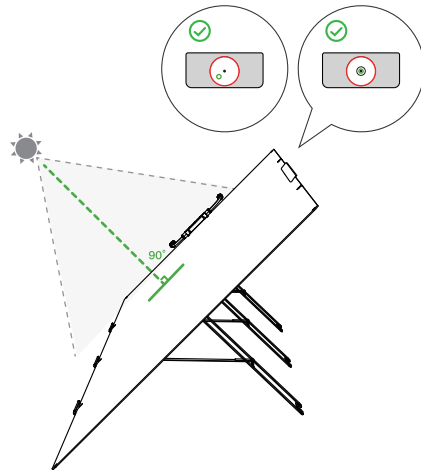
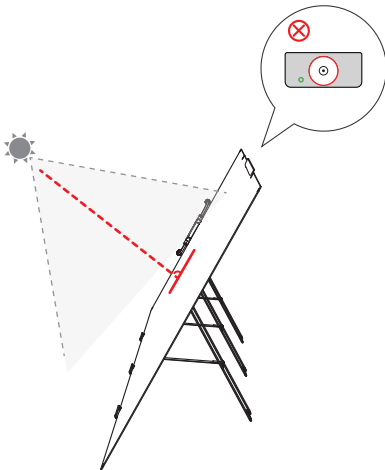
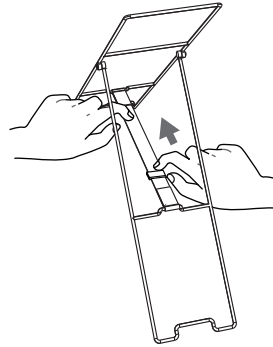
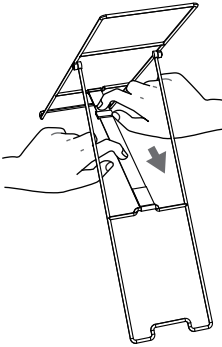

# Connection Method

## ⚡ In Series

Please connect solar panels in same specifications, and it is recommended to connect solar panels in same specifications.

	In Series	Example
Total Voltage	Adds up	$36.0V \times 3$
Total Current	Same as single solar panel	12.72A
Total Power	Total Voltage*Total Current	$36.0V \times 3 \times 12.72A$

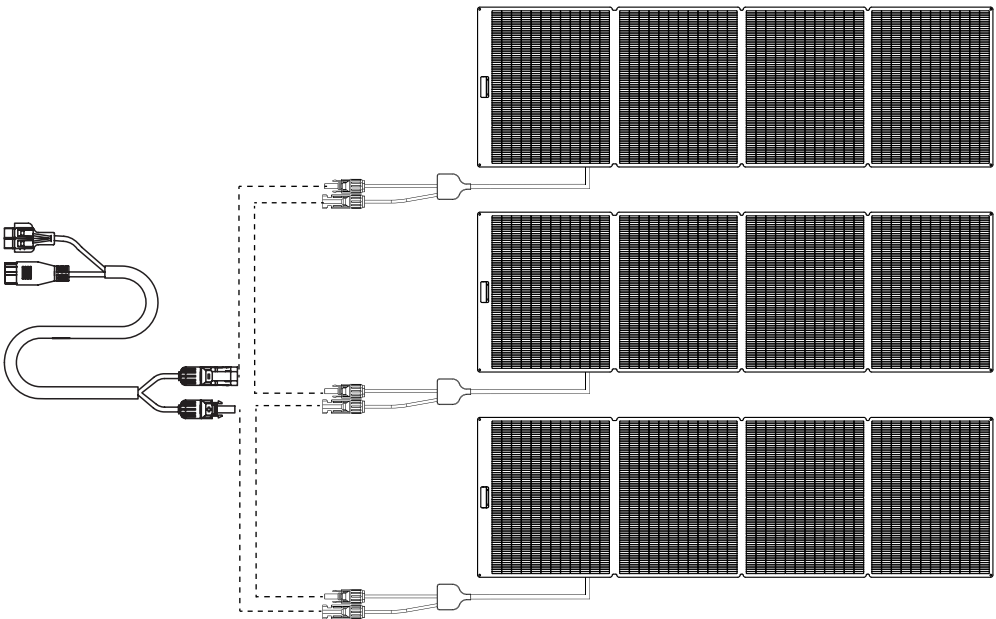

# Connection Method

## ⚡ In Parallel

Please connect solar panels in same specifications, and it is recommended to connect solar panels in same specifications.

	In Parallel	Example
Total Voltage	Same as single solar panel	36.0V
Total Current	Adds up	$12.72A \times 3$
Total Power	Total Voltage*Total Current	$36.0V \times (12.72A \times 3)$

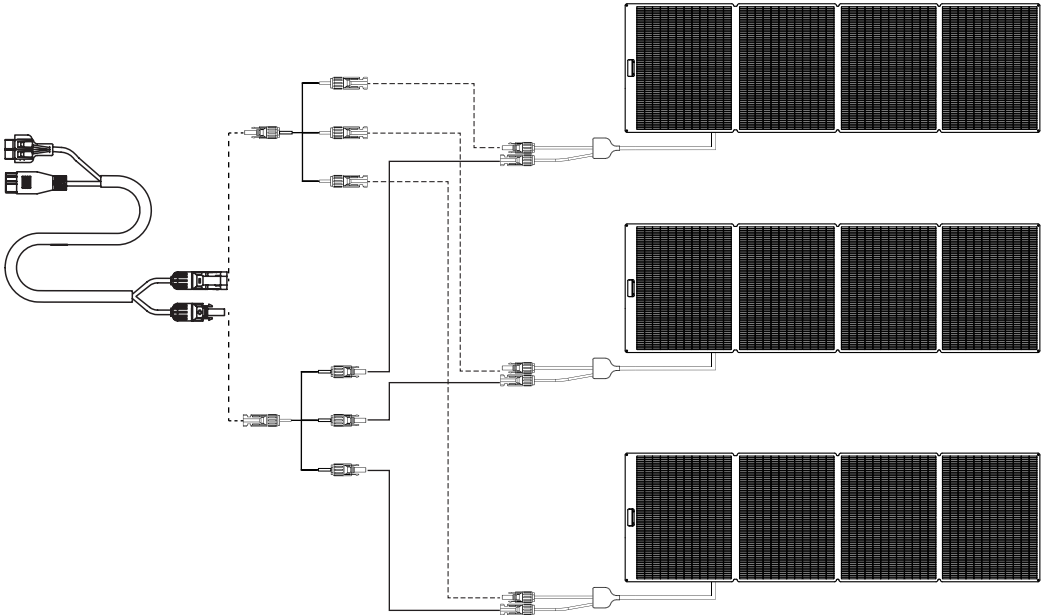

## 1.How to clean the product?

Please use a dry, soft, clean cloth or paper towel to gently wipe the product.

## 2.How to maintain the product?

- (1) Please store the solar panel in dry and neat place.
- (2) Avoid placing heavy objects on the solar panel.
- (3) Avoid damaging the surface and cable, like scratching, erosion, bump and so on.

# Compliance and Certification

## FCC Warning

This device complies with part 15 of the FCC Rules. Operation is subject to the following two conditions: (1) This device may not cause harmful interference, and (2) this device must accept any interference received, including interference that may cause undesired operation. Any changes or modifications not expressly approved by the party responsible for compliance could void the user's authority to operate the equipment.

Notice:

This equipment has been tested and found to comply with the limits for a Class B digital device, pursuant to part 15 of the FCC Rules. These limits are designed to provide reasonable protection against harmful interference in a residential installation. This equipment generates uses and can radiate radio frequency energy and, if not installed and used in accordance with the instructions, may cause harmful interference to radio communications. However, there is no guarantee that interference will not occur in a particular installation. If this equipment does cause harmful interference to radio or television reception, which can be determined by turning the equipment off and on, the user is encouraged to try to correct the interference by one or more of the following measures:

- (1) Reorient or relocate the receiving antenna.
- (2) Increase the separation between the equipment and receiver.
- (3) Connect the equipment into an outlet on a circuit different from that to which the receiver is connected.
- (4) Consult the dealer or an experienced radio/TV technician for help.

This equipment complies with FCC radiation exposure limits set forth for an uncontrolled environment.

This equipment should be installed and operated with minimum distance 20cm between the radiator & your body.

